

## ROCKFON 4'x4' Shiplap Panels (SLP)

### Shiplap Panels (SLP)

SLP panels are a unique asymmetrical ceiling panel that allows for the grid to be concealed, creating a smooth ceiling design. Shiplap panels are accessible when there are no penetrations in the panel. However, installation of an SLP panel is different than other concealed ceiling panels in the ROCKFON product line. This technical note is designed to help provide greater understanding to this product.

Shiplap panels are not recommended for installation in any Seismic Design Category. Consult with a local engineer of record or authority having jurisdiction to verify acceptance for your project.

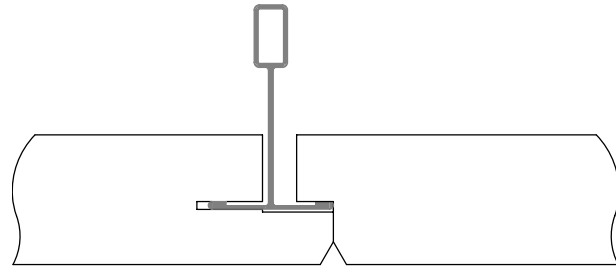

### Applicable ROCKFON SLP Panels

Sonar: 16457 - 4'x4'

### Special Handling

It is recommended that 4'x4' panels are handled and installed into the ceiling plane by two installers to reduce possibility of damage due to mishandling.

### ROCKFON SLP Panels

The ROCKFON SLP panels are comprised of two supporting and two non-supporting edges. The two supporting edges have different profiles, shown below (D1 and D2). The other two edges are the same profile (C), and can be used as supporting or non-supporting edges, depending on where the panel is used in the ceiling assembly. The panel design is shown with cross sections below.

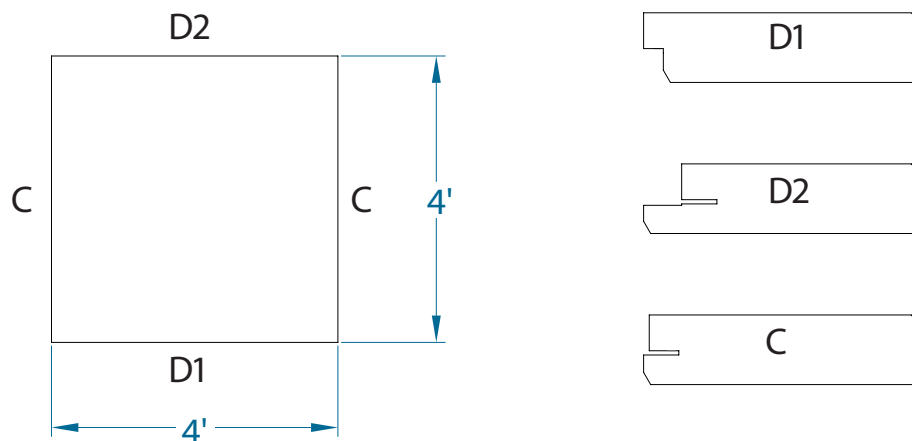

# ROCKFON 4'x4' Shiplap Panels (SLP)

## Grid Layout

4'x4' SLP panels work together in groups of 3 panels. The grid layout needs to provide ceiling modules of 4'x12' in order for proper panel installation and system accessibility. Install all grid per ASTM C636.

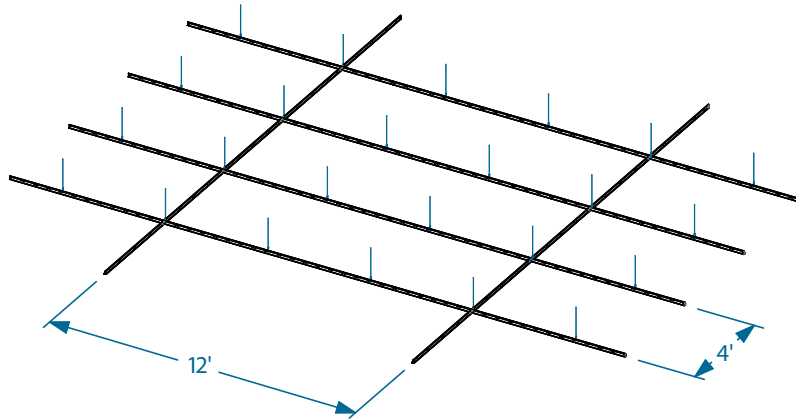

## Installation

Due to the large 4'x4' size, the 477.00 splines are required to mitigate sag of the panels due to the unsupported edges. To build one complete 12'x4' module, three (3) SLP panels and four (4) 477.00 splines are required. 477.00 splines are installed into the C edges of the panels. Only the center panel of the 4'x12' module will require two (2) splines.

477.00 Spline

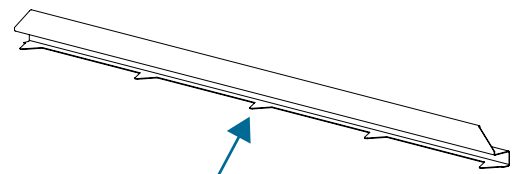

Push in fingers bite into the panel fibers

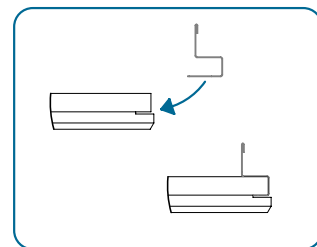
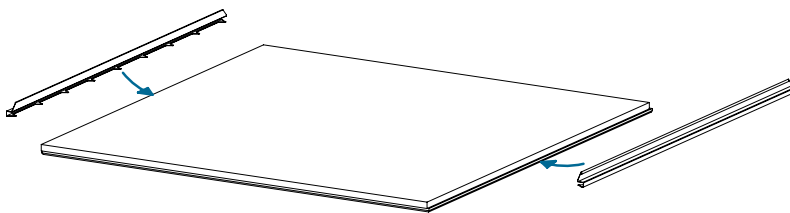

# ROCKFON 4'x4' Shiplap Panels (SLP)

## Installation, continued

Below is a cross section of a 4'x12' module to show the placement of the 477.00 splines.

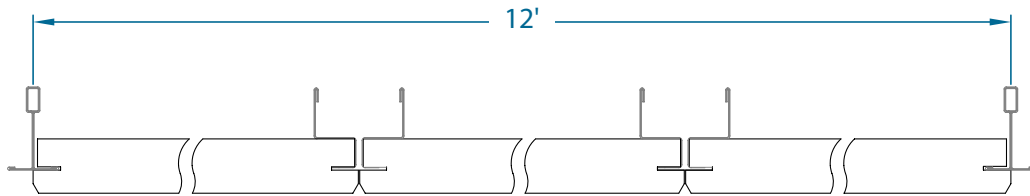

## Installation Process for ROCKFON 4'x4' SLP Panels into the 4'x12' Opening

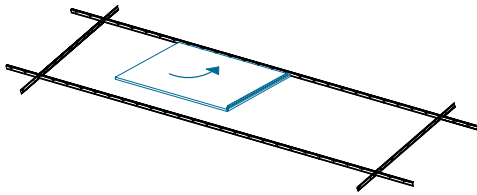

From above the grid, place the SLP panel with one (1) 477.00 spline onto the main runner. Push the panel so that the D2 edge seats into the grid. Allow the panel to come to rest on the opposite D1 edge.

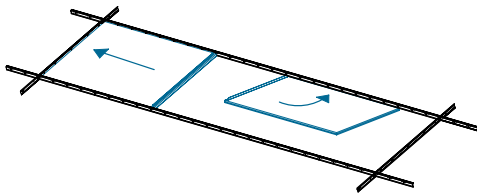

Push the panel so that the open C edge of the panel slides into the 4' cross tee. The 477.00 spline will create the support on the open side. Repeat this process with the opposite side of the 4'x12' opening.

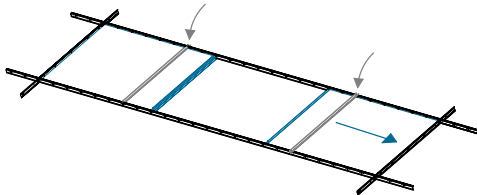

With both edge panels in place, install a 828.00H: 4' spacer bar over the top of both panels just inside of the 477.00 splines.

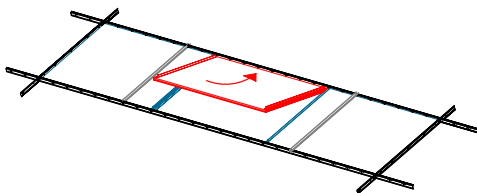

The center panel is the last component to complete a 4'x12' module. This panel installs the same as the perimeter panels except it remains in the center and both C edges have 477.00 splines installed in them.

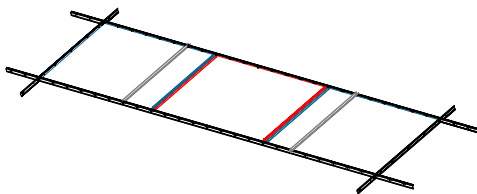

The middle panel is the accessible panel, however if more space is required to access the plenum, reverse the steps above to remove additional panels.

# ROCKFON 4'x4' Shiplap Panels (SLP)

## Lights and Other Penetrations

Due to the asymmetrical edges of SLP panels, lay in light fixtures and air diffusers may create an unacceptable aesthetic. It is recommended to use flange or pennant-style fixtures where possible. Note that where penetrations occur, this will cause the panel to be inaccessible. Keep accessibility in mind when creating the layout for your grid and mechanicals.

## Wall Enclosures

Any standard wall angle can be used, the suspension must be 1/2" above the wall angle. Hanger wires can be used to set the grid above the angle or a 90° corner clip can be used to anchor the grid to the wall.

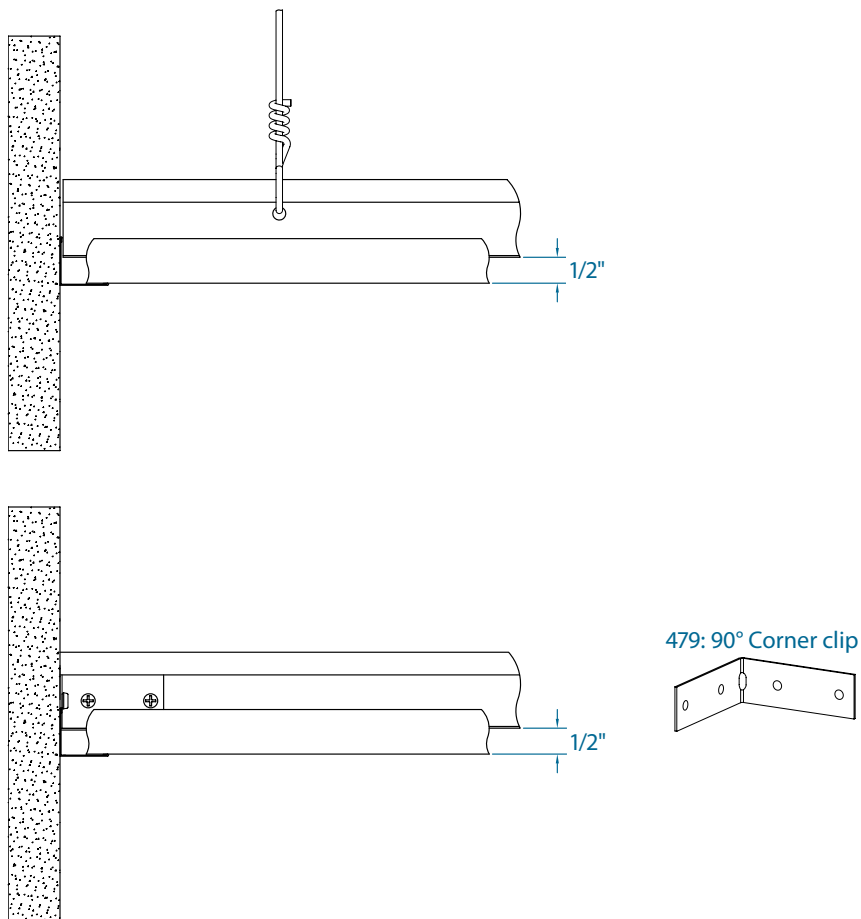

## Have questions?

Contact the ROCKFON Technical Services Team by calling 800-323-7164, prompt 3 and we can provide assistance on your project.



ROCKFON 4849 SOUTH AUSTIN AVE., CHICAGO, IL 60638 / USA and Canada: 800-323-7164 / Fax: 800-222-3744 / rockfon.com