

Rockfon[®] Infinity[™] Standard Perimeter Trim

Includes Pre-Packaged Infinity[™] Products

Features & Benefits

- Finish edge trim for interior suspended ceiling perimeters.
- Available pre-finished in straight lengths with square cut ends.
- Factory Mitered Corner Kits available.
- Variety of height and finish options available.
- Integrates with Chicago Metallic[®] Ceiling Suspension, Rockfon Stone Wool Ceiling Panels, Rockfon Metal Ceiling systems and industry standard T-Bar grid.

Applications

- Ceiling Projections
- Free-floating Islands
- Light Coves
- Ceiling Height Transitions



Rockfon® Infinity™ Standard Perimeter Trim

LEED® v4.1 Highlights

Materials and Resources (MR)

- Waste Management Planning ✓
- Interiors Life Cycle Impact Reduction ✓
- Environmental Product Declarations ✓
- Sourcing of Raw Materials ✓
- Material Ingredients -
- Waste Management ✓

Indoor Environmental Quality (EQ)

- Low-Emitting Materials ✓
- Interior Lighting -
- Acoustic Performance -

Recycled Content: Aluminum 75%

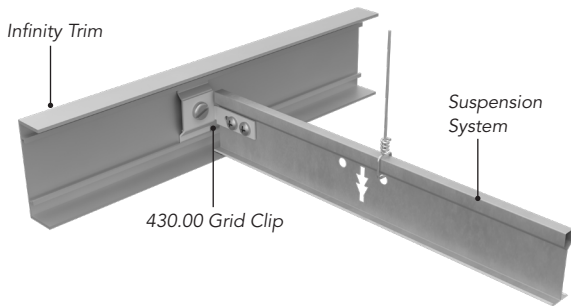

Infinity Standard - Straight 12' Pieces

Family Number & Name	Profile	Dimensions			Material	Fire Class	Low VOC	Recycled Content
		Height	Flanges	Length				
Standard Infinity 252427 INFS:STD		2"	3/4"	144"	Extruded Aluminum	A	✓	75%
		4"	3/4"	144"				
		6"	3/4"	144"				
		8"	3/4"	144"				
		10"	3/4"	144"				
		12"	3/4"	144"				

Product Code Example:

INFS:STD:6":44:None

Family Number | Height | Color
INFS:STD | **6"** | **44**
 Standard Infinity | Satin Silver

Available in straight 12' lengths only.

Panels will have square cut ends.

Unpainted galvanized grid clips, splices, and corner splices included on Engineered projects.

Rockfon® Infinity™ Standard Perimeter Trim

LEED® v4.1 Highlights

Materials and Resources (MR)

- Waste Management Planning ✓
- Interiors Life Cycle Impact Reduction ✓
- Environmental Product Declarations ✓
- Sourcing of Raw Materials ✓
- Material Ingredients -
- Waste Management ✓

Indoor Environmental Quality (EQ)

- Low-Emitting Materials ✓
- Interior Lighting -
- Acoustic Performance -

Recycled Content: Aluminum 75%









Outside Corner Kit



Inside Corner Kit

Factory Mitered Corner Kits



Profile	Profile Height	Type	Rockfon Reference Number	Corner Splices Per Corner	414.00 Splice Plates Per Corner	Fire Class	Recycled Content
 Inside Corner INCK:IN	2"	Inside	252594	1	2	A	75%
		Outside		1	2		
 Inside Corner INCK:IN	4"	Inside		2	4		
		Outside		2	4		
 Inside Corner INCK:IN	6"	Inside		2	4		
		Outside		2	4		
 Outside Corner INCK:OUT	8"	Inside		2	4		
		Outside		2	4		
 Outside Corner INCK:OUT	10"	Inside		3	6		
		Outside		3	6		
 Outside Corner INCK:OUT	12"	Inside		3	6		
		Outside		3	6		

Sold by the individual Corner Kit.

Can be purchased in colors to match Infinity Standard Perimeter Trim.

Corner Clips and Splices included.

360 degree painting is available.

Rockfon® Infinity™ Standard Perimeter Trim

LEED® v4.1 Highlights

Materials and Resources (MR)

- Waste Management Planning ✓
- Interiors Life Cycle Impact Reduction ✓
- Environmental Product Declarations ✓
- Sourcing of Raw Materials ✓
- Material Ingredients -
- Waste Management ✓

Indoor Environmental Quality (EQ)

- Low-Emitting Materials ✓
- Interior Lighting -
- Acoustic Performance -

Recycled Content: Aluminum 75%

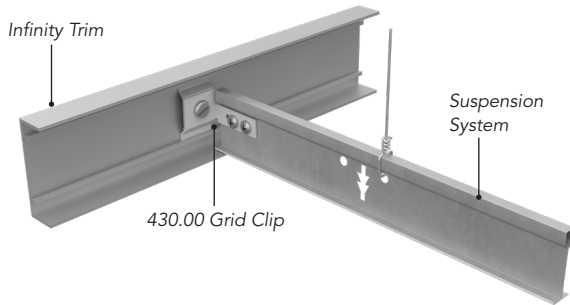

Pre-Packaged Infinity Profiles

Straight 12' Infinity pieces, pre-packaged with grid clips and straight splices.



Square cut ends on Infinity.

Pre-Packaged Inside and Outside Corner Kits available.

Profile	Profile Height	Finish	Item Number	Rockfon Reference Number	Pieces per Carton	LFT per Carton	430.00 Grid Clips per Carton	414.00 Splice Plates per Carton
	2"	White	8002.01	315456	6	72	36	6
	4"	White	8004.01	315457	6	72	36	12
	6"	White	8006.01	315458	4	48	24	8

For colors other than White, please order from the Standard Program.

Pre-Packaged Infinity Corner Kits - Inside and Outside - White

Profile	Profile Height	Type	Finish	Item Number	Rockfon Reference Number	Corners per Carton	Corner Splices per Carton	414.00 Splice Plates per Carton
 Inside Corner	2"	Inside	White	8002.01ICK	284496	4	4	8
		Outside	White	8002.01OCK	284497	4	4	8
 Outside Corner	4"	Inside	White	8004.01ICK	284501	4	8	16
		Outside	White	8004.01OCK	284499	4	8	16
	6"	Inside	White	8006.01ICK	284504	4	8	16
		Outside	White	8006.01OCK	284502	4	8	16

4 Corner Kits per Carton.

Sold in full carton quantities only.

For colors other than White, please order individual corner kits.

Rockfon® Infinity™ Standard Perimeter Trim

LEED® v4.1 Highlights

Materials and Resources (MR)

- Waste Management Planning ✓
- Interiors Life Cycle Impact Reduction ✓
- Environmental Product Declarations ✓
- Sourcing of Raw Materials ✓
- Material Ingredients -
- Waste Management ✓

Indoor Environmental Quality (EQ)

- Low-Emitting Materials ✓
- Interior Lighting -
- Acoustic Performance -

Recycled Content: Aluminum 75%

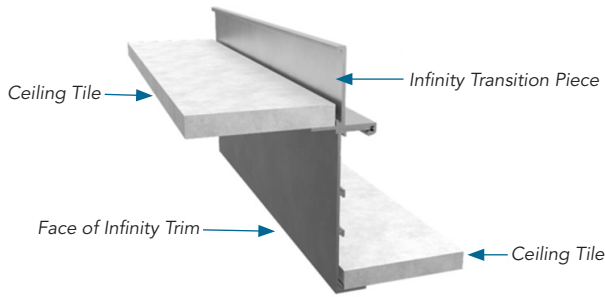

Infinity Transition Profile

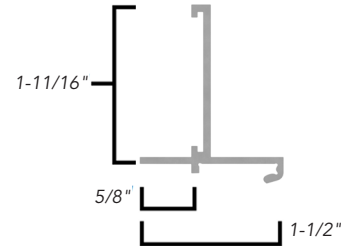

Pre-Packaged Infinity Transition

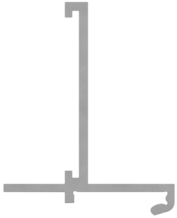
Profile	Description	Catalog Number	Rockfon Material Number	Color	Length	Pieces per Carton	Linear Feet per Carton
	12' Infinity Transition	8100.01	294573	White	12'	6	72

Sold in full carton quantities

Infinity Transition is compatible with the following Infinity products:

- Standard Infinity 2", 4", 6", and 8" - Straight profiles
- Infinity CDX
- Infinity R

Assembly

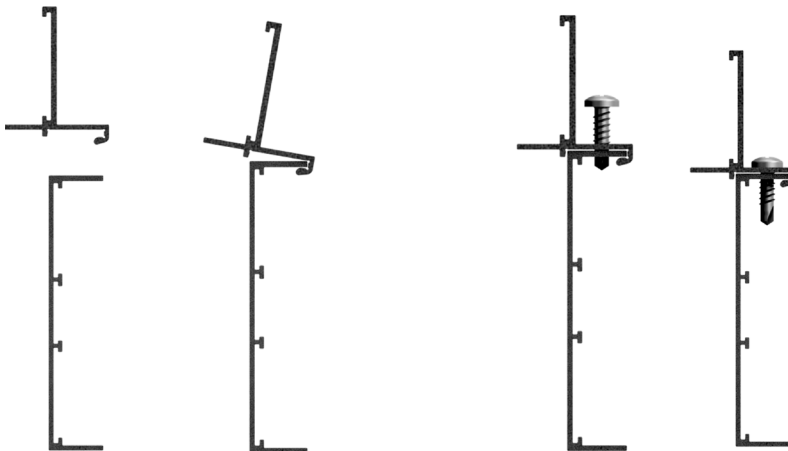

Rockfon® Infinity™ Standard Perimeter Trim Color Chart

Standard Colors

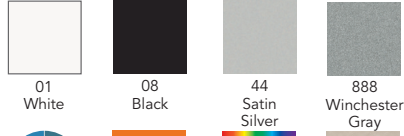

Other Painted Colors



Woodlands™ Solid Coordinating Colors

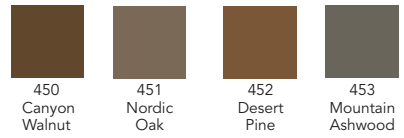

Metalwood® Solid Coordinating Colors

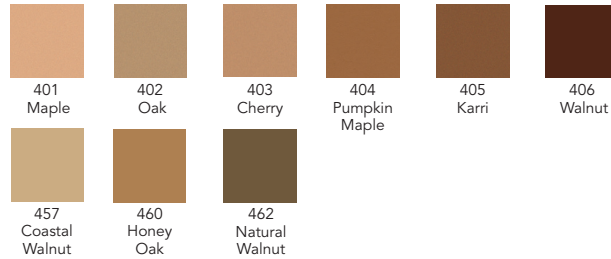

Woodscenes® Finishes



Colors shown are reproduced as close as possible to actual product color within the limitations of printing technology. Color chips are available upon request and should be reviewed before making a final selection. Variations in color matches of system components to ceiling panels can result from slight differences in texture, room lighting, painting process and subjectivity of observers.

As stated in CISCAs "Metal Ceilings Technical Guidelines," site conditions can impact installed visual appearance of metal ceilings. Usage of high gloss and metallic finishes in areas of critical lighting may alter final appearance and should be considered for finish selection.

Rockfon® Infinity™ Standard Perimeter Trim

Profile Sizes - Available as Straight 12' Lengths

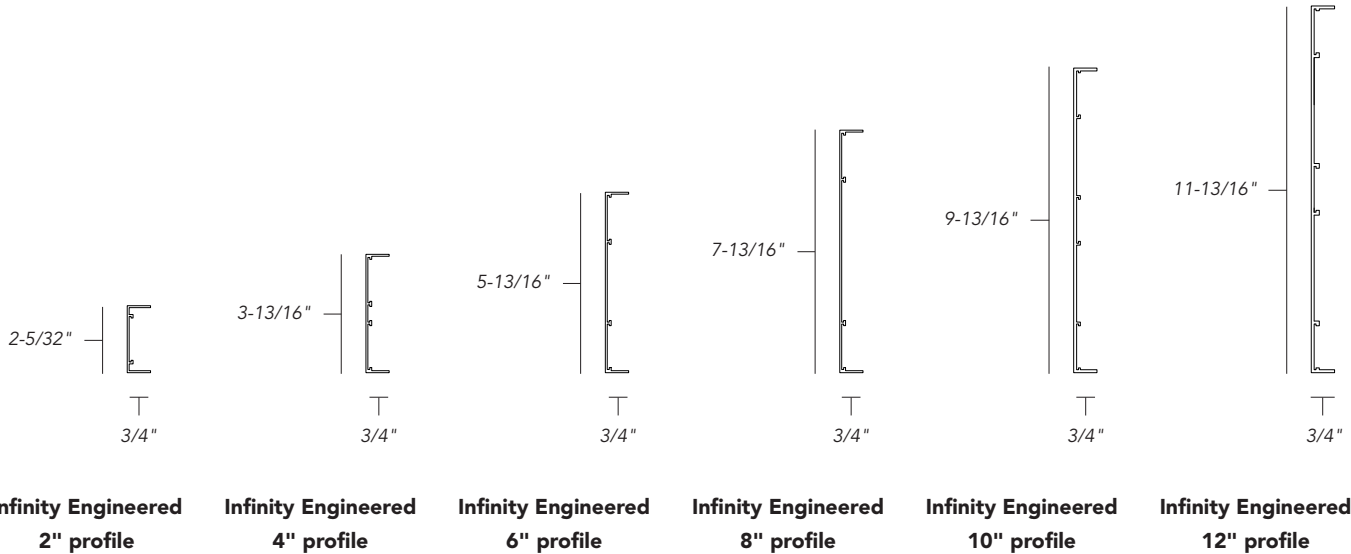

Compatibility

Infinity Engineered Straight Standard Profile and Infinity Engineered Curved Standard Profile are compatible with:

- Chicago Metallic® Ceiling Suspension systems
- Rockfon Metal Ceiling suspension systems
- Industry standard T-Bar grid systems

See datasheets of Chicago Metallic® Ceiling Suspension systems and Rockfon Metal Ceiling systems for more information.

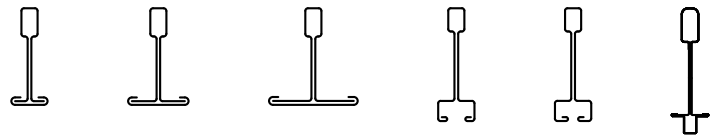

Chicago Metallic® Grid Profiles

Rockfon® Infinity™ Standard Perimeter Trim

Accessories



414.00 Straight Splice
Splices Perimeter Trim Sections
249358

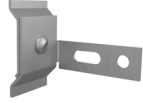

430.00 Grid Clip
Suspension to Trim
249361



417.00 Inside Corner Splice
For Splicing at Inside Corners
249359



429.00 Outside Corner Splice
For Splicing at Outside Corners
249360



446.36.000 Paired Infinity
Bracket 2" for 3/4" Reveal
249545



446.46.00 Paired Infinity
Bracket 3" for 1-3/8" Reveal
249546



End Cap for Paired Infinity
(per order)
252595



Infinity to Concealed Panels
(per order)
448.9xxx/252596



448.940
Infinity to Planar Clip
252596



448.00
Infinity to Planostile Clip
249369

Grid Clip and Splice Plate Accessories Chart (accessories needed per Infinity Trim height - per 12' of Infinity Trim length)						
Accessory	Infinity Trim Height					
	2"	4"	6"	8"	10"	12"
Grid Clip						
430.00	6	6	6	6	6	6
Splice Plate - Square Cut Edge						
414.00	1	2	2	2	3	3
Corner Splice Plate						
417.00 - Inside	1	2	2	2	3	3
429.00 - Outside	1	2	2	2	3	3

Rockfon® Infinity™ Standard Perimeter Trim

Properties

Material

Extruded Aluminum



Fire Performance

Surface burning characteristics:
UL723 (ASTM E84) Flame Spread Index: 0
Smoke Developed Index: 0



Environment

75% recycled content
100% locally recyclable



Warranty

1-Year Limited Product Warranty
See rockfon.com



Hygiene

Metal provides no sustenance
to microorganisms



Cleaning

✓ Damp cloth

070924

Rockfon

4849 S. Austin Ave.
Chicago, IL 60638 USA