

Rockfon® CurvGrid™ EZ-Flex System

Features & Benefits

- Create dramatic arch ceilings, waves, vaults and islands for interior spaces.
- Curved and straight main tees connect with straight cross tees to form 24" wide ceiling modules.
- Concealed main tees, cross tees and obscured perimeter trim provide "frameless" appearance.
- Primary Carrier Support for tees and trim requires fewer hanger wires.
- GREENGUARD Gold certification available with Woodlands™ woodgrain finishes.

Applications

- Assembly Halls
- Auditoriums
- Lobbies
- Schools
- Hospitals



Project – Heartland Payment Systems in Jefferson, IN
Product – Rockfon® CurvGrid™ EZ-Flex System

Rockfon® CurvGrid™ EZ-Flex System

LEED® v4.1 Highlights

Materials and Resources (MR)

- Waste Management Planning ✓
- Interiors Life Cycle Impact Reduction ✓
- Environmental Product Declarations ✓
- Sourcing of Raw Materials ✓
- Material Ingredients -
- Waste Management ✓

Indoor Environmental Quality (EQ)

- Low-Emitting Materials ✓
- Interior Lighting -
- Acoustic Performance ✓

Recycled Content: 78% Aluminum
30% Steel

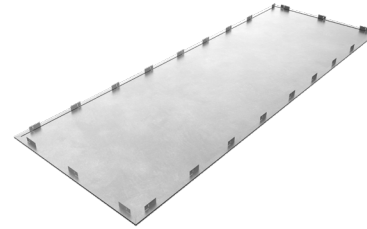
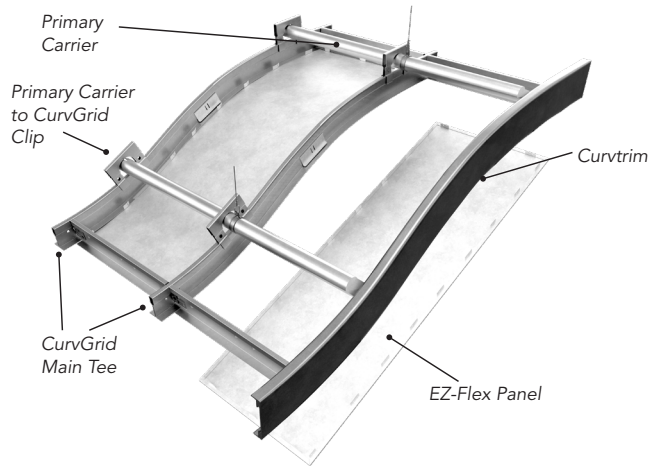

EZ-flex Panel



Family Number & Name	Edge Type	Dimensions		Perforations* (% Open Area)	Material	NRC	Fire Class	Low VOC	Recycled Content
		Width (w)	Length (l)						
252574 (CRVG)	 CEFP	24"	(w)x48: 48" (w)x72: 72" (w)x96: 96"	<u>Standard</u> SOLID: 0% V: 4.9% AA: 2.5% <u>Premium</u> See footnote* <u>Custom</u> CUST: **	0.032 Aluminum	Up to 0.90	A	✓	78%

Product Code Example:

252574:CRVG:CEFP:24x72:32AL.AA.Y

Family Number & Name

252574:CRVG

Size

24"x72"

Perforation

.032AL

Acoutex

AA

044

Y

Type

Material

Color

* See the Rockfon Performance Brochure for graphic representations of the perforations listed and the complete offering of Premium Perforation available.

** For designer specified perforation, contact Rockfon Technical Services at 1-800-323-7164 or techservices@rockfon.com

Note:

- Acoutex™ Backer standard with perforated panel.
- Perforated panel available without Acoutex.
- This system is not approved for exterior use.

Rockfon® CurvGrid™ EZ-Flex System

Color Chart

Standard Colors

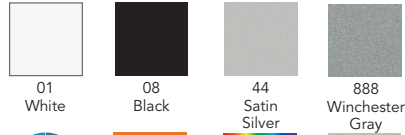

Other Painted Colors



Woodlands™ Wood-Look

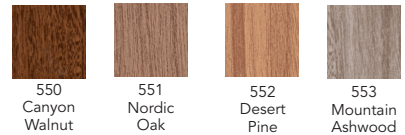

Woodlands™ Solid Coordinating Colors

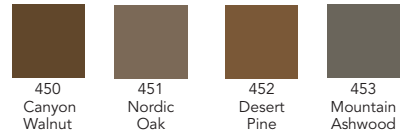

Metalwood™ Wood-Look Finishes (Interior Use Only)

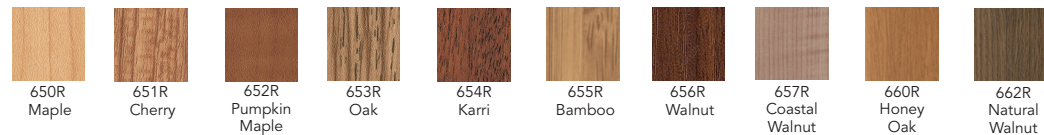

Metalwood™ Solid Coordinating Colors



Woodscenes™ Wood Look Powdercoat Finishes



Anodized Finishes

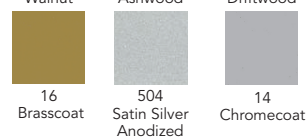

Colors shown are reproduced as close as possible to actual product color within the limitations of printing technology. Color chips are available upon request and should be reviewed before making a final selection. Variations in color matches of system components to ceiling panels can result from slight differences in texture, room lighting, painting process and subjectivity of observers.

As stated in Cisca's "Metal Ceilings Technical Guidelines," site conditions can impact installed visual appearance of metal ceilings. Usage of high gloss and metallic finishes in areas of critical lighting may alter final appearance and should be considered for finish selection.

- GREENGUARD Gold certification available with Woodlands™ woodgrain finishes.
- All Wood Look finishes will have the grain pattern applied parallel to the length of the panel.
- Metalwood Woodgrain finishes are a 0.008" vinyl laminate which replicates the look of real wood.
- Woodscenes finishes are a decorative powdercoat finish replicating real wood.
- Woodlands and Woodscenes finishes are suitable for interior and exterior use.
- Metalwood finishes are for interior use only.

Rockfon® CurvGrid™ EZ-Flex System

Standard Perforation Options

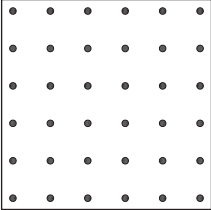

AA
62R354L

0.0625" Diameter holes
0.354" Straight centers
2.5% Open area

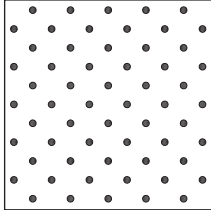

V
62R250D

0.0625" Diameter holes
0.25" Diagonal centers
4.9% Open area

See the Rockfon® Perforations Brochure for graphic representations of the perforations listed and the complete offering of Premium Perforations available.

Acoustical Performance

Rockfon CurvGrid System	NRC
NRC - Perforated with Acoutex Backer	0.70
NRC - Perforated with 1-1/2" Acoustical Pad	0.90

Rockfon® CurvGrid™ EZ-Flex System

Suspension

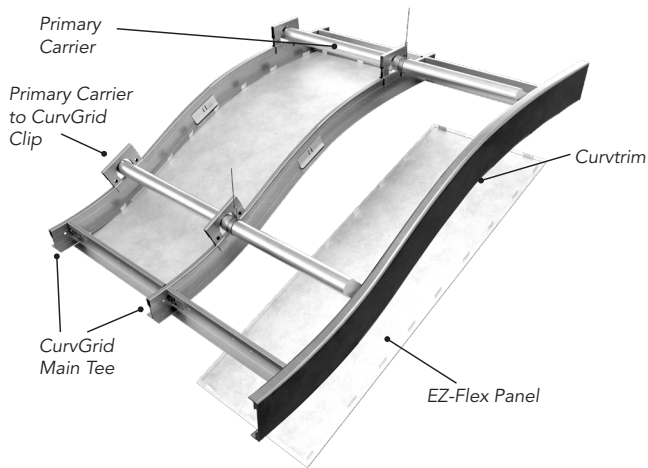

Suspension Components

Main Runner	Description	Catalog Number	Rockfon Part Number	Length	Height	Recycled Content
	Curved Main Runner Concave*	385.00.xxx	252583	As required per design	1-1/2"	30%
	Curved Main Runner Convex*	385.00.xxx	252583	As required per design	1-1/2"	30%
	CurvGrid Main Runner Straight Sections	385.00.xxx	252583	As required per design	1-1/2"	30%
	Primary Carrier Black	481.024.008	249651	As required per design	1-1/2"	30%
	Perimeter Cross Tee 2'	393.01.002.xxx	per order	As required per design	1-1/2"	30%
	Field Cross Tee 2'	383.00.002.xxx	per order			



*Minimum convex and concave suspension radius is 36".

Curvgrid suspension is made to order per the ceiling design. For pricing and ordering information, please contact Estimating at 1-800-323-7164 or estimating@rockfon.com

Rockfon® CurvGrid™ EZ-Flex System

Perimeter Trim

CurvTrim Extruded Aluminum Trim - Straight and Curved

Curvtrim Extruded Aluminum Trim	Description	Catalog Number	Rockfon Part Number	Length	Height	Recycled Content
	CurvTrim Straight	290.225.xxx	252584	As required per design	3/4" x 2-1/8" x 3/4"	78%
	CurvTrim Concave Curve*	291.225.xxx	252584	As required per design	3/4" x 2-1/8" x 3/4"	78%
	CurvGrid Convex Curve	291.225.xxx	252584	As required per design	3/4" x 2-1/8" x 3/4"	78%

*Minimum convex and concave perimeter trim radius is 36".

Curvtrim Perimeter Trim is made to order per the ceiling design. For pricing and ordering information, please contact Estimating at 1-800-323-7164 or estimating@rockfon.com

Rockfon® CurvGrid™ EZ-Flex System

Accessory Items

Product	Description	Catalog Number	Rockfon Material Number	Packaging
	Primary Carrier Splice	444.00	249367	Per order
	Primary Carrier Hanger Clip	441.00	250328	Per order
	Clear Hold Down Clip	8886.00	250382	100 pcs per carton
	Panel Clip	445.00	250329	Per order
	Primary Carrier to CurvGrid Clip	442.00	249365	Per order
	Primary Carrier to CurvTrim Clip	443.00	249366	Per order
	CurvGrid Main Tee Splice	436.00	250327	Per order
	Hold Down Insert	437.00	249364	Per order
	Outside Corner Clip	429.00	345470	Per order
	CurvTrim Splice Plate	434.00	249363	Per order
	Grid Attachment Clip	433.00	249362	Per order

Rockfon® CurvGrid™ EZ-Flex System

Acoustical Insulation



Acoustical Pads - Black Vinyl Wrapped

Description	Size	Color	Catalog Number	Rockfon Reference Number
Polywrapped Acoutical Pad 1" x 1#	2' x 2'	Black	58.01.059.008	250505
Polywrapped Acoutical Pad 1" x 1#	2' x 4'	Black	58.01.061.008	250507
Polywrapped Acoutical Pad 1-1/2" x 1#	2' x 2'	Black	58.01.064.008	250509
Polywrapped Acoutical Pad 1-1/2"x 1#	2' x 4'	Black	58.01.063.008	250508

Acoustical Performance

Rockfon Curvgrid System	NRC
NRC - Perforated with Acoutex Backer	0.70
NRC - Perforated with 1-1/2" Acoustical Pad	0.90

Rockfon® CurvGrid™ EZ-Flex System

Properties

Material

0.032 Aluminum and Galvanized Steel



Fire Performance

Surface burning characteristics:
UL723 (ASTM E84) Flame Spread Index: 0
Smoke Developed Index (UL Labeled): 0



Environment

Aluminum: 78% recycled content
Steel: 30% recycled content
100% locally recyclable



Sustainability

Woodlands™ woodgrain finishes are UL GREENGUARD Gold certified for low VOC (chemical) emissions and meet the California Department of Public Health (CDPH) Standard Method v1.2-2017 for offices and classroom environments



Warranty

1-Year Limited Product Warranty
See rockfon.com



Hygiene

Metal provides no sustenance to microorganisms



Cleaning

✓ Damp cloth

070924

Rockfon

4849 S. Austin Ave.
Chicago, IL 60638 USA