

Rockfon[®] Planostile[™] Snap-in Panel System

Features & Benefits

- Snap-in metal panel system installed on concealed suspension grid.
- Fully concealed edge types available for “seamless” or “articulated grid” look.
- Panels available in variety of finishes, sizes and materials.
- Wide range of perforations available for aesthetic and acoustic enhancements .
- System suitable for interior, exterior and seismic zone installations C and D, E, F.
- GREENGUARD Gold certification available with Woodlands[™] woodgrain finishes.

Applications

- Conference Rooms
- Lobbies
- Airport Terminals
- Transit Facilities

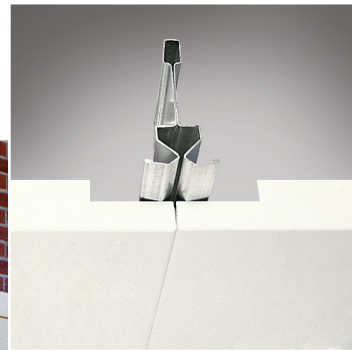

Project – State Employees Credit Union in Granite Quarry, NC
Product – Rockfon[®] Planostile[™] Snap-in

Rockfon® Planostile™ Snap-in Panel System

LEED® v4.1 Highlights

Materials and Resources (MR)

- Waste Management Planning ✓
- Interiors Life Cycle Impact Reduction ✓
- Environmental Product Declarations ✓
- Sourcing of Raw Materials ✓
- Material Ingredients -
- Waste Management ✓

Indoor Environmental Quality (EQ)

- Low-Emitting Materials ✓
- Interior Lighting -
- Acoustic Performance ✓

Recycled Content: Aluminum 78%
Steel 30%

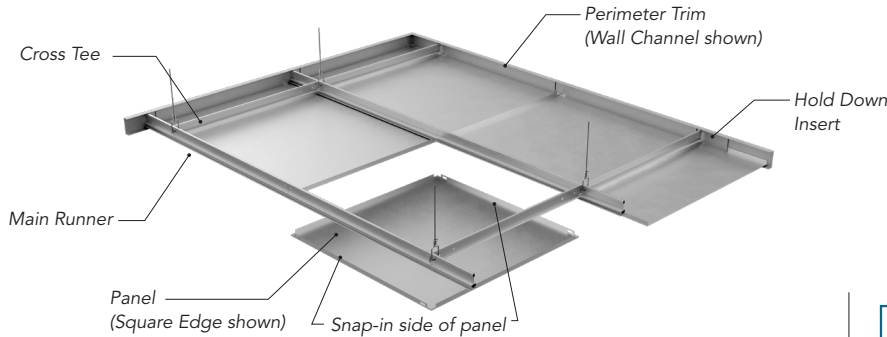

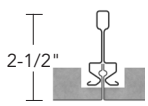
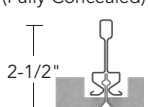
Family Number & Name	Edge Type	Dimensions	Perforations (% open area)	Material	NRC	Fire Class	Low VOC	Recycled Content
252588:PLST: Planostile™ Metal Panel	PSSE: Snap-in Square Edge (Fully Concealed) 	12 x 48: 12" x 48" 20 x 60: 20" x 60" 24 x 24: 24" x 24" 24 x 48: 24" x 48" 24 x 60: 24" x 60" CUST: **	<u>Standard</u> SOLID: 0% D: 16.2% E: 20.8% J: 58.2% Q: 70% R: 11.1% V: 4.9% AA: 2.5%	32AL: 0.032" Aluminum	up to 0.90	A	✓	78%
	PSBE: Snap-in Bevel Edge (Fully Concealed) 	24x24: 24" x 24"***	<u>Premium</u> see footnote * <u>Custom</u> CUST: **					

Product Code Example:

252588:PLST:PSSE:24x48:.32AL:44:V:Y

Family Number & Name:

252588 Planostile™ Metal Panel

Size

Color:

Satin Silver

Acoutex™:

Yes or No

252588:PLST: PSSE: 24x48: .32AL: 44: V: Y

Edge Type:
Snap-in Square Edge
(Fully Concealed)

Material:
0.032" Aluminum

Perforation:
4.9% Open Area

Approximate panel weight for aluminum panels= .50 lbs per square foot.
.024 HDG Steel panels are available on a custom order basis

* See the Rockfon Perforations Brochure for graphic representations of the perforations listed and the complete offering of Premium Perforations available.

** For designer specified Dimensions or Perforation, contact Rockfon Technical Services at 1-800-323-7164 or techservices@rockfon.com.

*** Non-perforated panel size labeled for UL 580 Class 30 system.

**** Only solid 24" x 24" aluminum panels approved for exterior use.

Note – Acoutex™:

- Acoutex backer standard with perforated panel.

- Perforated panel available without Acoutex™.

- For interior use only.

Rockfon® Planostile™ Snap-in Panel System

Color Chart

Standard Colors

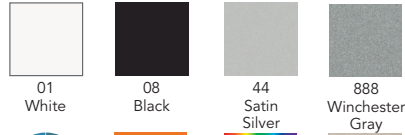

Other Painted Colors



Woodlands™ Wood-Look



Woodlands™ Solid Coordinating Colors

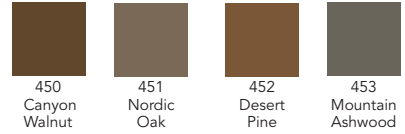

Metalwood™ Wood-Look Finishes (Interior Use Only)

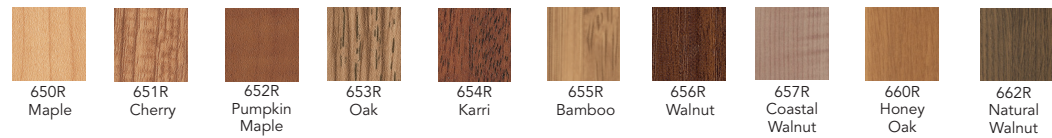

Metalwood™ Solid Coordinating Colors



Woodscenes™ Wood Look Powdercoat Finishes



Anodized Finishes

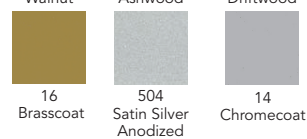

Colors shown are reproduced as close as possible to actual product color within the limitations of printing technology. Color chips are available upon request and should be reviewed before making a final selection. Variations in color matches of system components to ceiling panels can result from slight differences in texture, room lighting, painting process and subjectivity of observers.

As stated in Cisca's "Metal Ceilings Technical Guidelines," site conditions can impact installed visual appearance of metal ceilings. Usage of high gloss and metallic finishes in areas of critical lighting may alter final appearance and should be considered for finish selection.

- GREENGUARD Gold certification available with Woodlands™ woodgrain finishes.
- All Wood Look finishes will have the grain pattern applied parallel to the length of the panel.
- Metalwood Woodgrain finishes are a 0.008" vinyl laminate which replicates the look of real wood.
- Woodscenes finishes are a decorative powdercoat finish replicating real wood.
- Woodlands and Woodscenes finishes are suitable for interior and exterior use.
- Metalwood finishes are for interior use only.

Rockfon® Planostile™ Snap-in Panel System

Standard Perforation Options

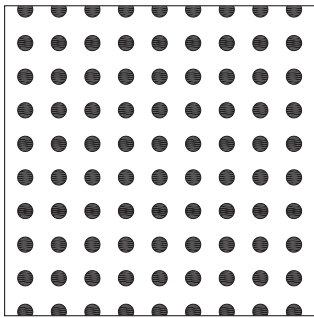

D
98R216L
0.098" Diameter Holes
0.216" Straight Centers
16.2% Open Area

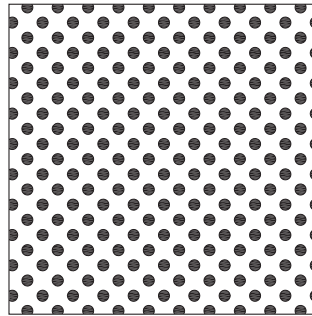

E
71R138D
0.071" Diameter Holes
0.138" Diagonal Centers
20.8% Open Area

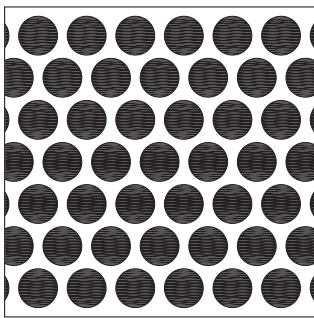

J
250R312S
0.25" Diameter Holes
0.312" Staggered Centers
58.2% Open Area

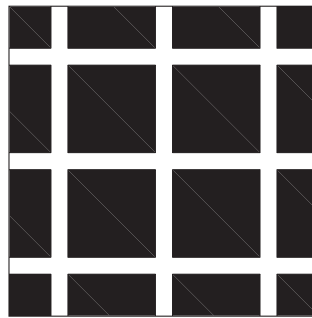

Q
562S672L
0.5625" Square Holes
0.672" Straight Centers
70% Open Area

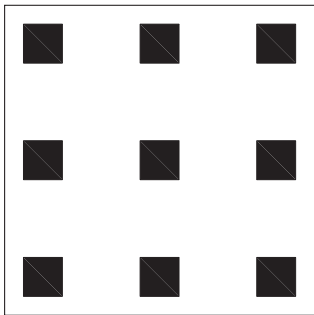

R
250S750L
0.25" Square Holes
0.75" Straight Centers
11.1% Open Area

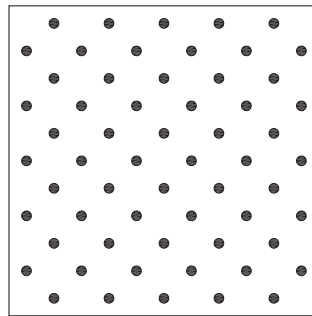

V
62R250D
0.0625" Diameter Holes
0.25" Diagonal Centers
4.9% Open Area

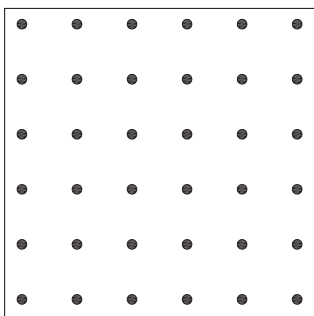

AA
62R354L
0.0625" Diameter Holes
0.354" Straight Centers
2.5% Open Area

See the Rockfon Perforations Brochure for graphic representations of the perforations listed and the complete offering of Premium Perforations available.

Acoustical Performance

Planostile Snap-in Panels	NRC
NRC - Perforated with Acoutex™ Backer	0.70
NRC - Perforated with 1-1/2" Acoustical Pad	0.90

Rockfon® Planostile™ Snap-in Panel System

Suspension Components

Snap-in Panel Suspension

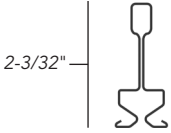
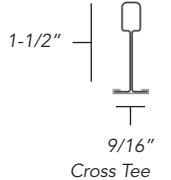
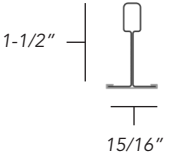
Detail	Description	Catalog Number	Structural Classification (ASTM C635)	Length x Height x Face	Slotting	Lbs/Piece	Recycled Content
Main Runners							
	12' Snap Bar Carrier	MA010.500CH	HD	144" x 2-3/32" x 15/16"	6" OC	4.9	30%
Cross Tees							
	9/16" Concealed Spacer Cross Tee	10.04.022UL.001	-	24" x 1-1/2" x 9/16"	No Slots	0.5	30%
	15/16" Cross Tee Stab End Butt Cut 2'	10.01.229UL.xxxH	-	24" x 1-1/2" x 15/16"	No Slots	0.5	30%
	15/16" Cross Tee Stab End Butt Cut 4'	10.01.209.xxxH	-	48" x 1-1/2" x 15/16"	12" OC	1	30%
	15/16" Cross Tee Stab Stepped End 5'	10.01.206.xxxH	-	60" x 1-1/2" x 15/16"	5 Slots: Midpoint, 10" Each Side of Midpoint, and 6" from Each End	1.25	30%

Main Runner Allowable Load Test Data Based on 1/360 Span Deflection (Lb/Ft*)

Main Runner	Length	Hanger Spacing	
		ASTM C-635 4')	5'
MA010.500CH	12'	HD	4.74

Cross Tee Allowable Load Test Data Based on 1/360 Span Deflection (Lb/Ft*)

Cross Tee	Length	Cross Tee Span		
		2'	4'	5'
10.04.022UL.xxxCH	2'	24.5^	-	-
10.01.229UL.xxxH	2'	16.5^	-	-
10.01.209.xxxH	4'	-	8.0^	-
10.01.206.xxxH	5'	-	-	7.5^

*To convert data into lb/sft, divide on center spacing of component into lb/ft
^Limited by safety factor of 2.

Rockfon® Planostile™ Snap-in Panel System

Perimeter Components

Wall Channels

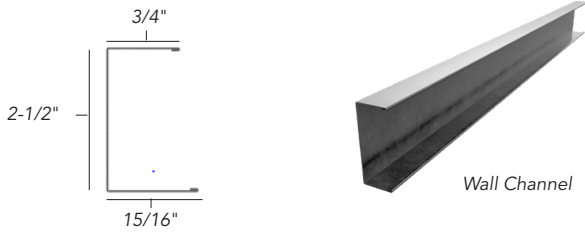

Description	Catalog Number	Length, Height x Face x Top Flange	Length	Lbs/Piece
10' Aluminum Wall Channel	60.00.008.xxx	120", 15/16" x 2-1/2" x 15/16"	120"	2.2

Wall Angles

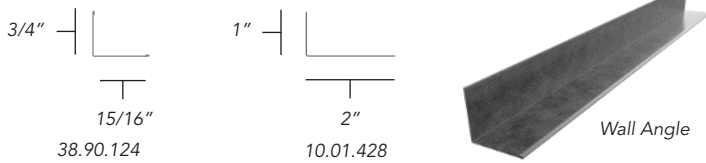

Description	Catalog Number	Length, Height x Face	UOM	Lbs/UOM
Aluminum Wall Angle with Hemmed Edges - 300 ft. per Carton	38.90.124.xxx	144" x 3/4" x 15/16"	Carton	25
Seismic Wall Angle - Steel, with Hemmed Edges	10.01.428.xxx	144" x 1" x 2"	Piece	1.8

Infinity Perimeter Trim

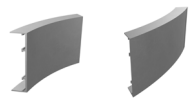
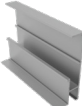
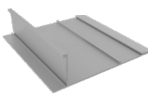
Perimeter Trim	Product	Part Number	Length	Height	Packaging
	Engineered Straight	252565 / INFE:STD	12' Max	2", 4", 6", 8", 10", 12"	As Needed
	Engineered Curved	252566 / INFC:STD	12' Max	2", 4", 6", 8", 10", 12"	As Needed
	Infinity R Reveal Edge	252565 / INFE:REV	12' Max	4"	As Needed
	Infinity Z Razor Edge	252565 / INFE:RAZ	12' Max	2" High 6" Flange	As Needed

Rockfon® Planostile™ Snap-in Panel System

Accessory Items

Hold Down Inserts for 2-1/2" Channel

Item	Description	Catalog Number	Rockfon Reference Number	Lbs/Piece
 60.00.031, 60.00.032 60.00.033, 60.00.034	Steel Hold Down Insert 11" x 2-7/16"	60.00.031	249676	0.25
	Steel Hold Down Insert 22" x 2-7/16"	60.00.032	249677	0.5
	Aluminum Hold Down Insert 11" x 2-7/16"	60.00.033	249678	0.2
	Aluminum Hold Down Insert 22" x 2-7/16"	60.00.034	249679	0.4

Accessory Items

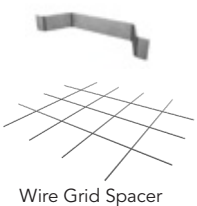
Item	Description	Catalog Number	Rockfon Reference Number
 Wire Grid Spacer	Wall Spring 5/8 Face" x 7/8" Deep	63.26.202	254302
	Reinforcement Bar - UL90	MA020G.500H	252245
	24" x 24" Wire Grid Spacer	60.00.021	250526
	Planostile Removal Tool	911.00	250344

Exterior UL580 - Class 30 Accessories for Exterior Soffits

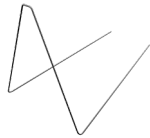

Panel Retainer Clip



Brace Attachment Clip

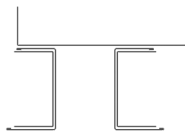

Expansion Joint Assembly

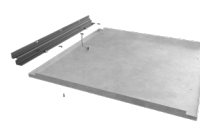

Access Door Assembly

Description	Catalog Number	Rockfon Reference Number	Pieces per Carton	Weight per Carton
Panel Retainer Clip	63.26.031	250568	500	7
Bracing to Snap Bar Carrier Attachment Clip	63.26.032	250569	100	1
Expansion Joint Assembly	63.26.035.xxx	*	1	5
Access Door Assembly	63.26.033.xxx	*	1	6

Acoustical Pads - Black Vinyl Wrapped

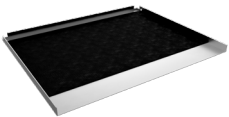
Item	Description	Catalog Number	Rockfon Reference Number	Lbs/Piece
	2' x 2' Poly-Wrapped Acoustical Pad 1" x 1#	58.01.059.008	250505	0.5
	2' x 4' Poly-Wrapped Acoustical Pad 1" x 1#	58.01.061.008	250507	1
	2' x 2' Poly-Wrapped Acoustical Pad 1.5" x 1#	58.01.064.008	250509	0.75
	2' x 4' Poly-Wrapped Acoustical Pad 1.5" x 1#	58.01.063.008	250508	1.5

Rockfon® Planostile™ Snap-in Panel System

Panel Installation Details

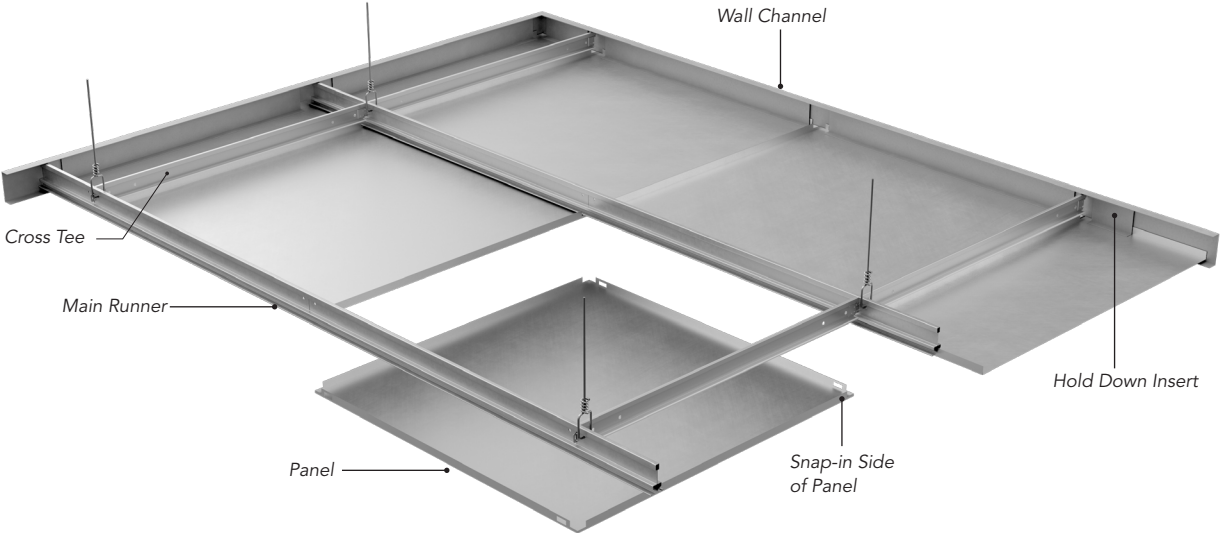

General Layout Drawings

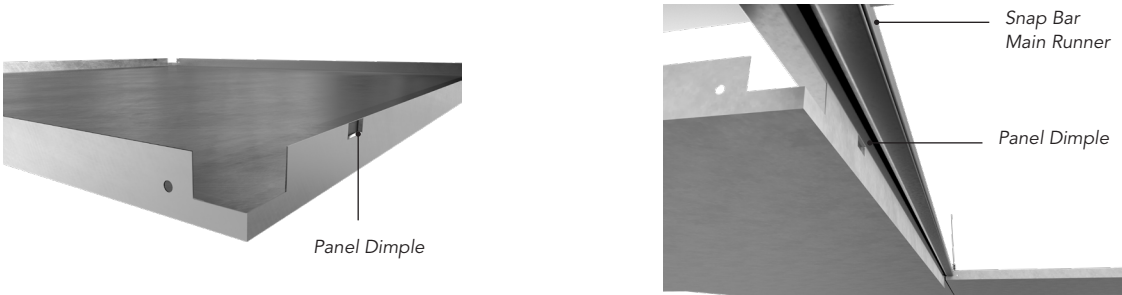

Panel Installation

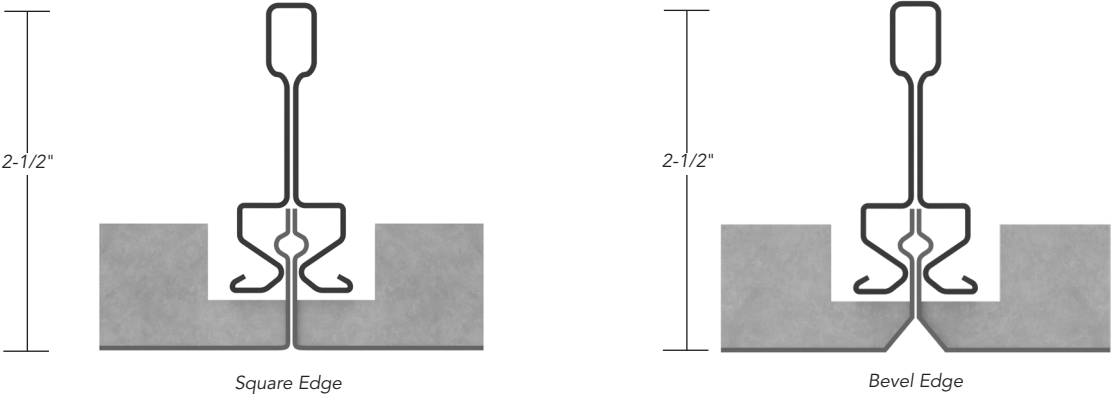

Panel Edge Options

Note: Bevel Edge available on 2' x 2' panels only

Rockfon® Planostile™ Snap-in Panel System

Installation Details

Perimeter Installation Details

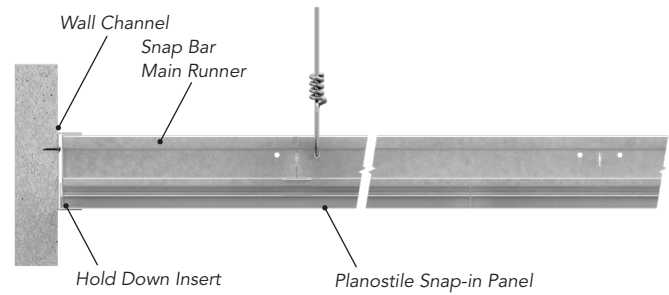
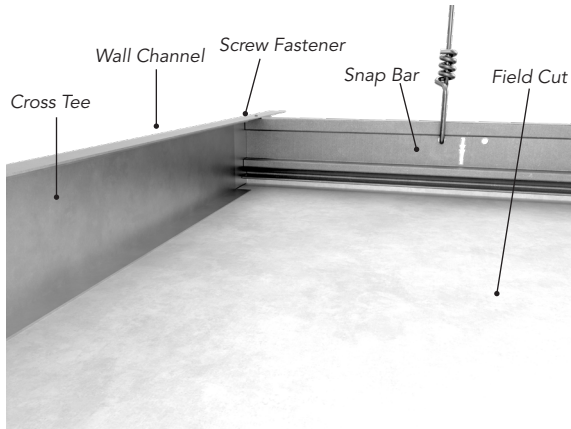

Perimeter Installation Using Wall Channel

Side View

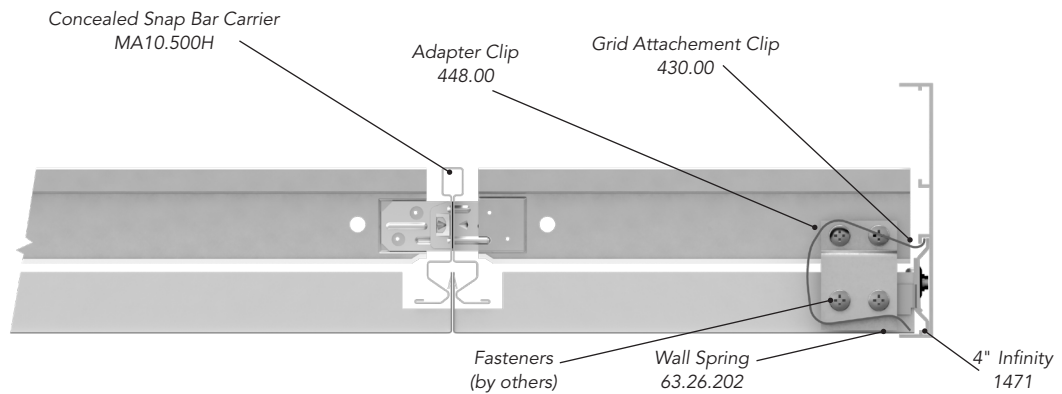

Installation with Infinity and 430.00 Grid Clips

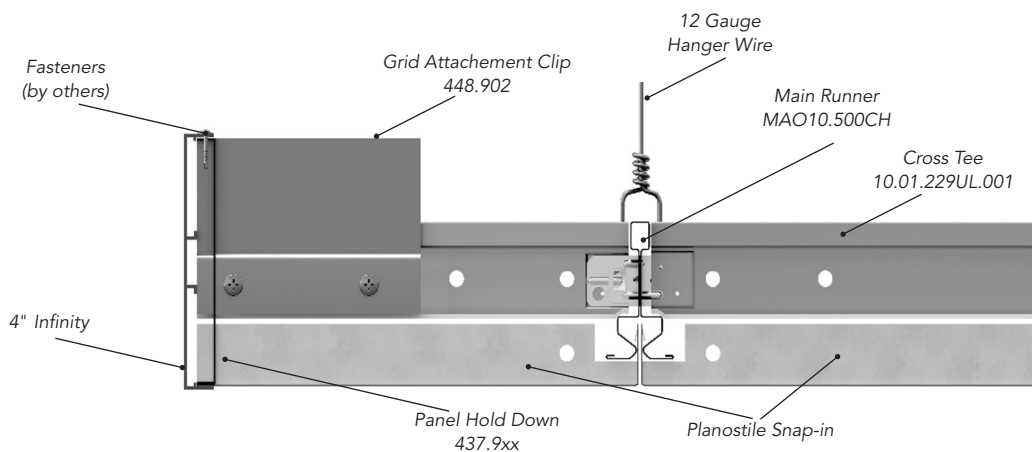

Infinity Installation Using Attachment Bracket

Rockfon® Planostile™ Snap-in Panel System

Exterior Installation Details

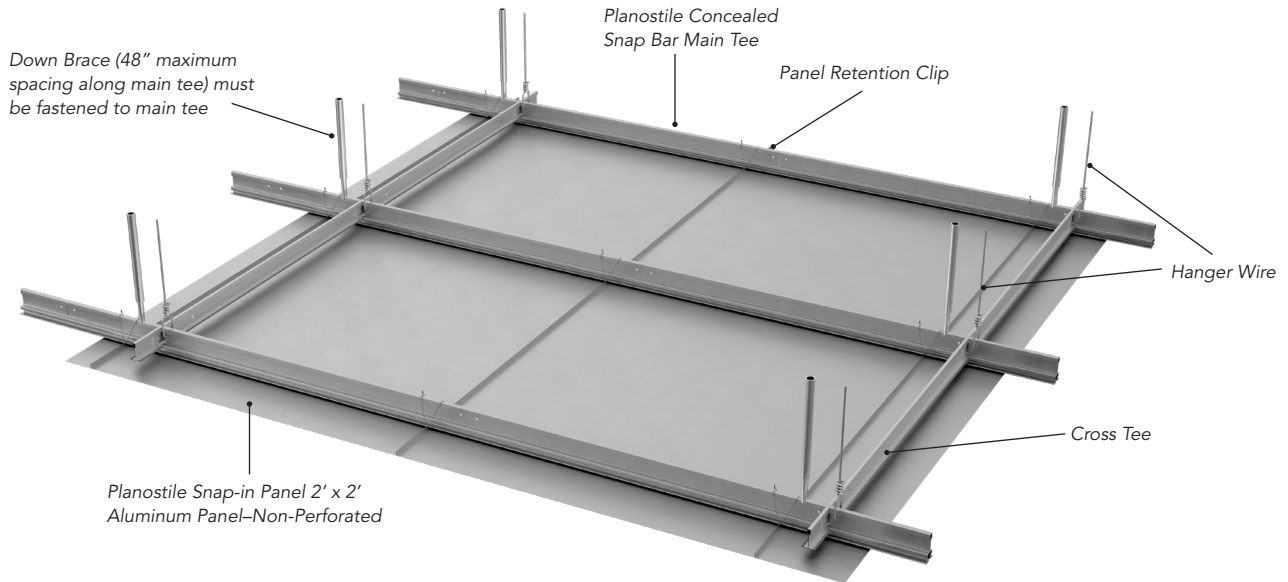

Exterior PSF 30 Installation

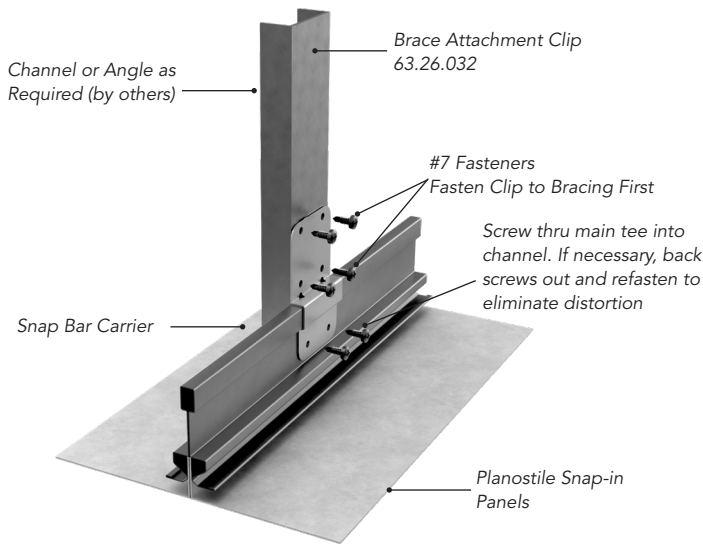

Down Brace Attachment

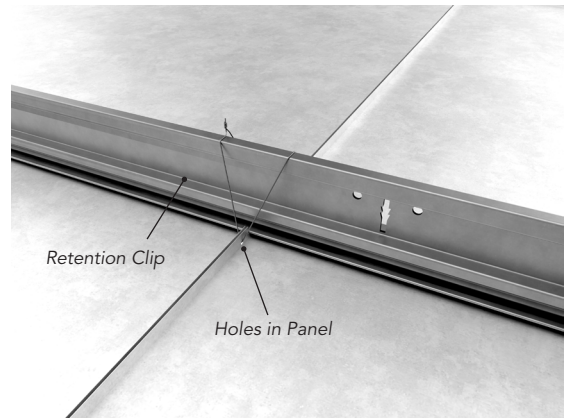

Installation of Panel Retention Clips

Physical Data	
Type:	Snap-In Panel System
Material	Painted Aluminum, Painted Galvanized Steel or Reflective Anodized Aluminum
Panel Sizes:	12" x 48", 24" x 24", 24" x 48", 20" x 60", 24" x 60", Custom Sizes Available
Fire:	Class A per ASTM E84
Performance:	Use for Interior or Exterior Spaces
Suspension:	Snap-In Suspension
Warranty:	1-year Limited
Sustainability:	Steel: 30% Recycled; Aluminum 78%

Material	
Suspension:	ASTM C635 HD Main Tee Commercial Quality Steel, Hot Dipped Galvanized
Panels:	.032 Aluminum, .032 Anodized Aluminum

Rockfon® Planostile™ Snap-in Panel System

Properties

Material

0.032" Aluminum



Fire Performance

Surface burning characteristics:
UL723 (ASTM E84) Flame Spread Index: 0
Smoke Developed Index (UL Labeled): 0



Environment

Aluminum: 78% recycled content
Steel: 30% recycled content
100% locally recyclable



Sustainability

Woodlands™ woodgrain finishes are UL GREENGUARD Gold certified for low VOC (chemical) emissions and meet the California Department of Public Health (CDPH) Standard Method v1.2-2017 for offices and classroom environments



Hygiene

Metal provides no sustenance to microorganisms



Cleaning

✓ Damp cloth



Warranty

1-Year Limited Product Warranty
See rockfon.com

070824

Rockfon

4849 S. Austin Ave.
Chicago, IL 60638 USA

Tel. +1-800-323-7164
cs@rockfon.com
rockfon.com

2024 | Subject to alterations in range and product technology without prior notice. Rockfon accepts no responsibility for printing errors.
© ROCKWOOL A/S 2022. All rights reserved.
® denotes a trademark that is registered in the United States of America.