

## Rockfon® Spanair® Hook-in

### Features & Benefits

- Metal panel system for grid suspension based interior installations
- Hook-in design allows downward accessibility without the use of tools
- Perimeter gasket feature facilitates ease of plank removal, plank alignment and anti-vibration
- Square edge panels fully conceal suspension grid for a "seamless" look
- Panels available in variety of sizes, finishes and perforations

### Applications

- Schools
- Passenger Terminals
- Corridors
- Assembly Halls
- Convocation Centers
- Stadiums

*Project – Cranbrook Kingswood Middle School for Girls in Bloomfield Hills, MI  
Product – Rockfon® Spanair® Hook-in Metal Panels*



# Rockfon® Spanair® Hook-in

## LEED® V4 HIGHLIGHTS

### Materials and Resources (MR)

- Waste Management Planning ✓
- Interiors Life Cycle Impact Reduction ✓
- Environmental Product Declarations ✓
- Sourcing of Raw Materials ✓
- Material Ingredients -
- Waste Management ✓

### Indoor Environmental Quality (EQ)

- Low-Emitting Materials ✓
- Interior Lighting -
- Acoustic Performance ✓

Recycled Content: up to 85%

Product Code Example: **252589:SPAN:SHIP:12x48:V:803:.40AL**

Edge Type:  
Hook-in, Square Edge  
(Fully Concealed)

Perforation:  
4.9% Open  
Area

Material:  
0.040" Aluminum

**252589:SPAN:** **SHIP:** **12x48:** **V:** **803:** **.40AL**

Family Number & Name:  
252589 Spanair® Metal Panel

Dimensions:  
12" x 48"  
(w x l)

Color:  
Burnished Cherry

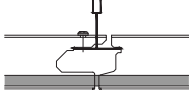
Family Number & Name	Edge Type	Dimensions		Perforations* (% open area)	Material	NRC	Fire Class	Light Reflectance	Low VOC
		Width (w)	Length (l)						
252589:SPAN: Spanair® Metal Panel	SHIP: Hook-in Square Edge (Fully Concealed) 	12x(l): 12"	(w)x48: 48"	Standard	.40AL: 0.040" Aluminum	up to 0.90***	A	-	✓
		24x(l): 24"	(w)x60: 60" (w)x72: 72" (w)x84: 84" (w)x96: 96" (w)x120: 120"	D: 16.2% E: 20.8% J: 58.2% Q: 70% R: 11.1% V: 4.9% AA: 2.5%					
				Premium see footnote *					
				Custom					
				CUST: **					

\* See the Rockfon Perforations Brochure for graphic representations of the perforations listed and the complete offering of Premium Perforations available.

\*\* For designer specified Perforation, contact Rockfon Technical Services at 1-800-323-7164 or techservices@rockfon.com.

\*\*\* NRC values are dependent on perforation patterns, plenum depth and acoustical backer options. Contact Rockfon Technical Services for more information at 1-800-323-7164 or techservices@rockfon.com.

Note:

- Acoutex™ Backer standard with perforated panel.
- Perforated panel available without Acoutex.
- This system is not approved for exterior use.

Choose from the above product options to build your product code

Family Number & Name	Edge Type	Dimensions	Perforation	Color*	Material
252589:SPAN:	SHIP:				.40AL

\* Select one of our many color options, located on page 3

Standard colors:



01 White



08 Black



44 Satin Silver



888  
Winchester  
Grey

Premium colors:



Color-all



Custom  
(color match)

Metallic colors:



795  
Champagne  
Metallic



796  
Beige  
Metallic



797  
Iron Glimmer  
Metallic



798  
Copper  
Metallic

Metalwood® Woodgrain Finishes<sup>▲</sup>:



650R  
Maple\*\*



651R  
Cherry\*\*



652R  
Pumpkin  
Maple\*\*



653R Oak\*\*



654R Karri\*\*



655R  
Bamboo\*\*

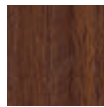

656R  
Walnut\*\*



401 Maple\*



402 Oak\*



403 Cherry\*



404 Pumpkin  
Maple\*



405 Karri\*



406 Walnut\*

Woodscenes® Painted Finishes<sup>†</sup>:



800  
Lazy Maple



801  
Aged Teak



803  
Burnished  
Cherry



804  
Sleek Cherry



805  
Weathered Oak

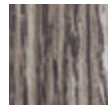

806  
Barnwood  
Grey

\* Coordinating solid color to match Metalwood Woodgrain Finishes.

\*\* Metalwood Woodgrain Finishes not available for Rockfon Infinity™ or Spanair Suspension; use coordinating solid color. See footnote \*.

▲ Metalwood Woodgrain Finishes are a 0.008" vinyl laminate that replicate real wood; variations in color and pattern will occur. For final panel thickness information contact Rockfon Technical Services at 1-800-323-7164 or techservices@rockfon.com. For interior use only.

† Woodscenes Painted Finishes are a decorative powder coat finish that replicate real wood; variations in color and pattern will occur.

Note:

- Metalwood and Woodscenes grain direction is parallel to the length of the panel.

- See rockfon.com for more information on color options.

Colors shown are reproduced as close as possible to actual product color within the limitations of printing technology. Color chips are available upon request and should be reviewed before making a final selection. Variations in color matches of system components to ceiling panels can result from slight differences in texture, room lighting, painting process and subjectivity of observers.

**Spanair Hook-in Suspension**

Detail	Product Number	Duty Rating	Length	Slotting	Spacing	Finish
Main Runner*						
	10.00.410	Heavy Duty (HD)	144"	8" O.C. (Cross Tee) 12" O.C. (panels)	see footnote **	galvanized
Cross Tee (Stab-in)						
	10.00.412	NA <sup>1</sup>	24"	single slot at midpoint	48" O.C.	White finish - standard
	10.00.414		48"			
	10.00.415		60"			
	10.00.416		72"			
	10.00.417		84"			
	10.00.418		96"			

\* Suspension system for Spanair based on Chicago Metallic® Ceiling Suspension. Reference ICC-ES Evaluation Report ESR-2631 for testing information.

\*\* Short side of Hook-in panels connect to suspension system at Main Runner locations Main Runner spacing determined by panel length.

<sup>1</sup> Not Applicable - Duty rating applies only to main runners with a 4-ft span.

## Spanair Hook-in Perimeter Trim

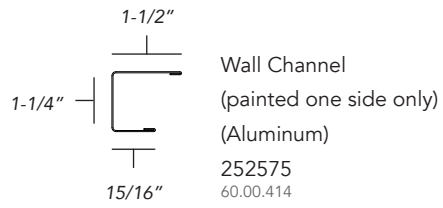

Wall Channel  
(painted one side only)  
(Aluminum)  
252575  
60.00.414

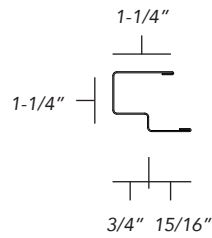

Wall Channel with reveal  
(painted one side only)  
(Aluminum)  
252575  
60.00.415

**Note:**

- Wall Channel available in Standard, Premium, Metallic, Metalwood and Woodscenes finishes.

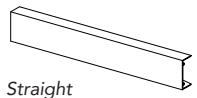

Straight



Curved

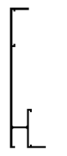

Reveal

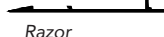

Razor

Perimeter Trim

(Rockfon Infinity)

(see Infinity data sheet)

Infinity Engineered Straight Profile

Infinity Engineered Curved Profile

Infinity Standard Straight Profile

Infinity R (Reveal) Edge Profile

Infinity Z (Razor) Edge Profile

**Note:**

- See Infinity Data Sheet for finish options.

## Spanair Hook-in System Accessories



Hold Down Insert -  
for Wall Channel  
(1-1/8" height; 3/4" faces;  
10" or 22" length)  
(Aluminum)  
60.12.430

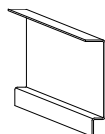

Infinity Attachment  
Bracket  
(Aluminum)  
448

*Note:*  
- For Infinity Attachment Bracket detail  
information, contact Rockfon Technical  
Services at 1-800-323-7164 or  
[techservices@rockfon.com](mailto:techservices@rockfon.com).

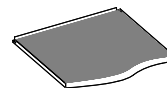

Acoustical Pads  
(Poly-Wrapped Fiberglass)  
(Black Plastic Wrap)

24" x 24" x 1"	250505
	58.01.059.008
24" x 24" x 1-1/2"	250509
	58.01.064.008
24" x 48" x 1"	250507
	58.01.061.008
24" x 48" x 1-1/2"	250508
	58.01.063.008

## Spanair Hook-in Standard Details

### System Depth

#### - Panel at Suspension

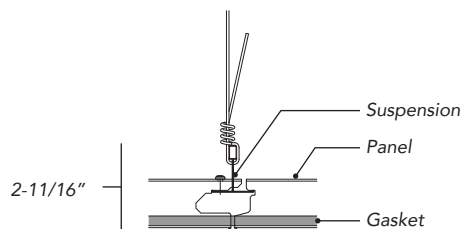

### Panel Detail

#### - Gasket location

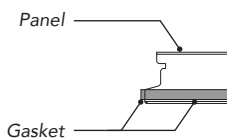

### Wall Channel

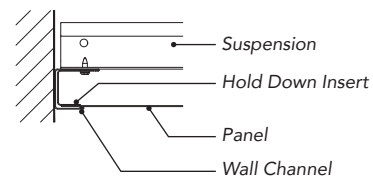

## Rockfon Infinity Perimeter Trim

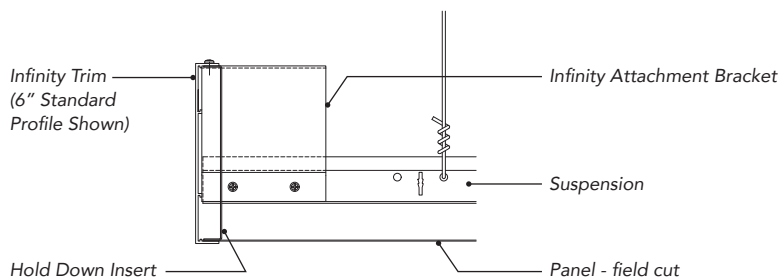

## Spanair Hook-in System Detail

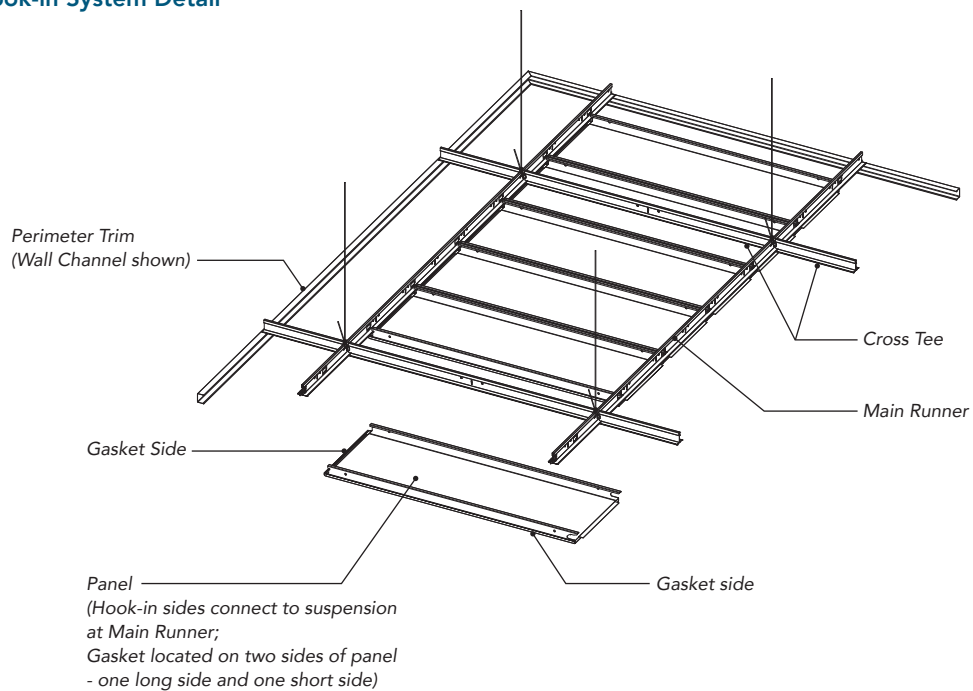



## Material

0.040" Aluminum



### Fire Performance

Surface burning characteristics:  
UL723 (ASTM E84)  
Flame Spread Index: 0  
Smoke Developed Index  
(UL Labeled): 0



### Hygiene

Metal provides no sustenance  
to microorganisms



### Warranty

1-Year Limited  
Product Warranty.  
See [rockfon.com](http://rockfon.com)



### Environment

- Up to 85% recycled content
- 100% locally recyclable



### Cleaning

- Damp Cloth

080819

## Rockfon

4849 S. Austin Ave.  
Chicago, IL 60638 USA