

Rockfon® Curvgrid™

Two-directional System

Features & Benefits

- Create dramatic arch ceilings, waves, vaults and islands for interior spaces
- Curved and straight main tees connect with straight cross tees and perimeter trim to form 24" x 24" standard ceiling modules
- Fully visible main tees, cross tees and perimeter trim
- Primary Carrier support for tees and trim requires fewer hanger wires
- Use with or without flexible infill panels

Applications

- Assembly Halls
- Auditoriums
- Lobbies
- Schools
- Hospitals

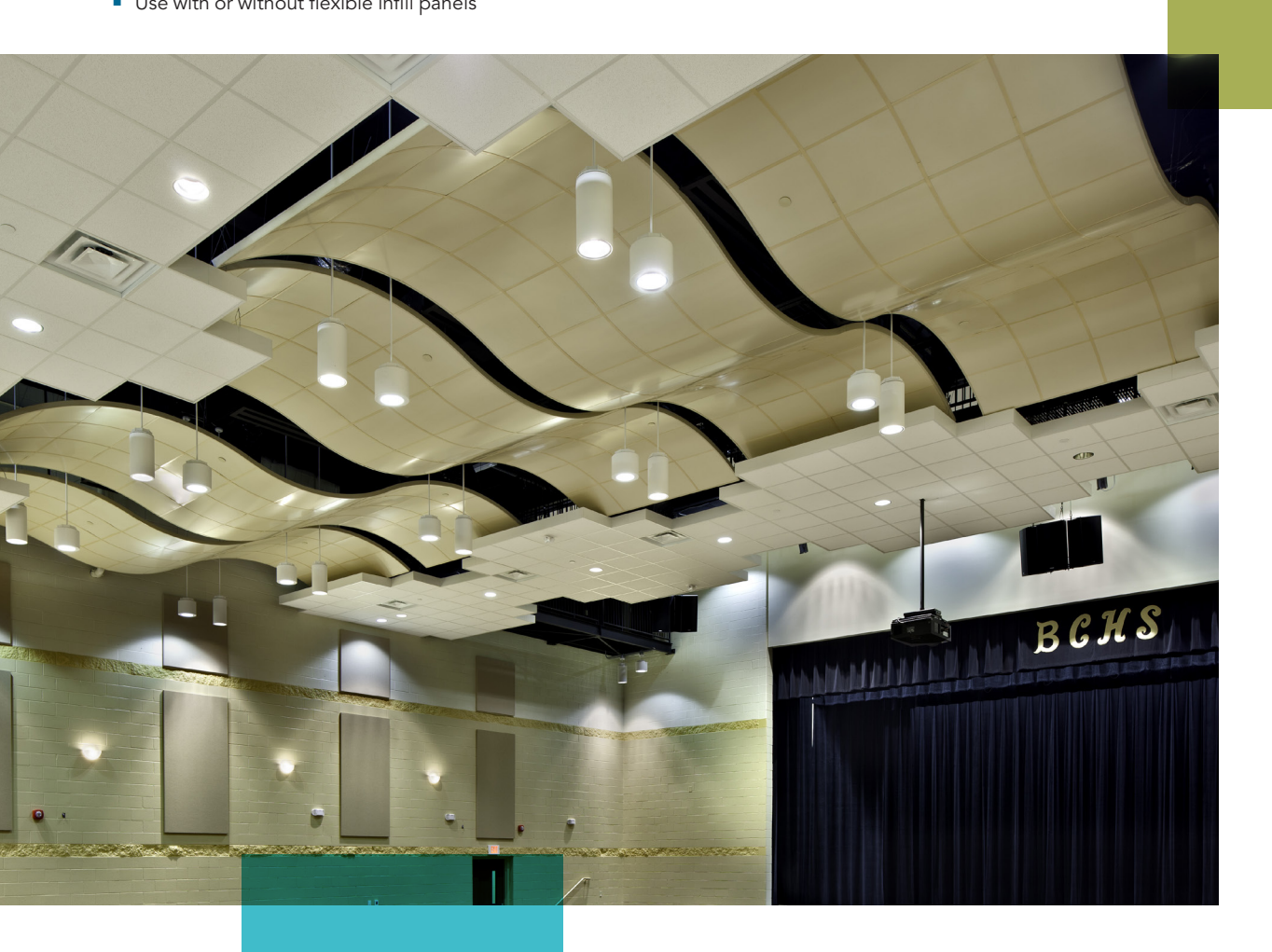

Project – Bradley Central High School in Cleveland, TN
Product – Rockfon® Curvgrid™ Two-directional System

Rockfon® Curvgrid™

Two-directional System

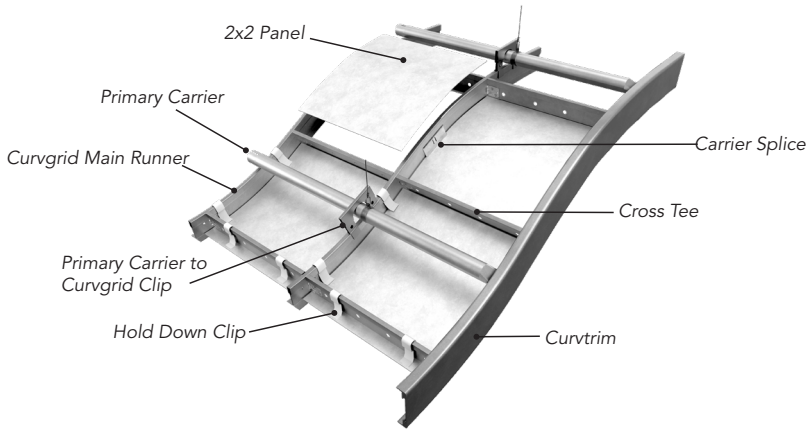

LEED® v4.1 Highlights

Materials and Resources (MR)

- Waste Management Planning ✓
- Interiors Life Cycle Impact Reduction ✓
- Environmental Product Declarations ✓
- Sourcing of Raw Materials ✓
- Material Ingredients -
- Waste Management ✓

Indoor Environmental Quality (EQ)

- Low-Emitting Materials ✓
- Interior Lighting -
- Acoustic Performance ✓

Recycled Content: 85% Aluminum
30% Steel

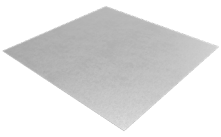

Family Number & Name	Edge Type	Dimensions		Perforations* (% Open Area)	Material	NRC	Fire Class	Low VOC	Recycled Content
		Width (w)	Length (l)						
252574 (CRVG)	 (CTDP)	24"	24"	Standard SOLID: 0% D: 16.2% E: 20.8% J: 58.2% Q: 70% R: 11.1% V: 4.9% AA: 2.5% Premium See footnote* Custom CUST: **	0.032 Aluminum	Up to 0.90	A	Yes	85%

Product Code Example:

252574:CRVG:CTDP:24x24:.32AL.E.Y

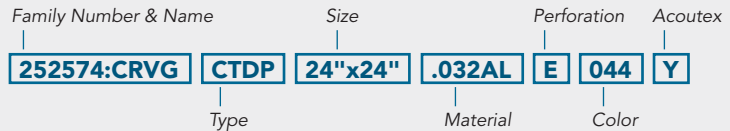

* See the Rockfon Performance Brochure for graphic representations of the perforations listed and the complete offering of Premium Perforation available.

** For designer specified perforation, contact Rockfon Technical Services at 1-800-323-7164 or techservices@rockfon.com

Note:

- Acoutex™ Backer standard with perforated panel.
- Perforated panel available without Acoutex.
- This system is not approved for exterior use.

Curvgrid™ Color Chart

Standard Colors:



01
White



08
Black



44
Satin Silver



888
Winchester
Grey

Premium Colors:



Color
Chart



RAL
COLOURS



Custom
(Color Match)

Metalwood® Woodgrain Finishes†:



650R
Maple**



651R
Cherry**



652R
Pumpkin
Maple**



653R
Oak**



654R
Karri**



655R
Bamboo**



656R
Walnut**



401
Maple*



402
Oak*



403
Cherry*



404
Pumpkin
Maple*



405
Karri*



406
Walnut*

Woodscenes® Painted Finishes†:



800
Lazy Maple



801
Aged Teak



803
Burnished
Cherry



804
Sleek Cherry



805
Weathered
Oak

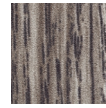

806
Barnwood
Grey

* Coordinating solid color to match Metalwood Woodgrain Finishes.

** Metalwood Woodgrain Finishes not available for Rockfon Curvgrid Suspension, Curvtrim or panels wider than 24"; use coordinating solid color. See footnote*.

† Metalwood Woodgrain Finishes are a 0.008" vinyl laminate that replicate real wood; variations in color and pattern will occur. For interior use only.

† Woodscenes Woodgrain Painted Finishes are a decorative powder coat finish that replicate real wood; variations in color and pattern will occur.

Note:

- Metalwood and Woodscenes grain direction is parallel to the length of the panel.

- See rockfon.com for more information on color options.

Colors shown are reproduced as close as possible to actual product color within the limitations of printing technology. Color chips are available upon request and should be reviewed before making a final selection. Variations in color matches of system components to ceiling panels can result from slight differences in texture, room lighting, painting process and subjectivity of observers.

Rockfon® Curvgrid™ Two-directional System

Standard Perforation Options

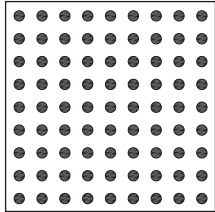

D
98R216L
0.098" Diameter holes
0.216" Straight centers
16.2% Open area

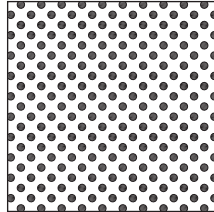

E
71R138D
0.071" Diameter holes
0.138" Diagonal centers
20.8% Open area

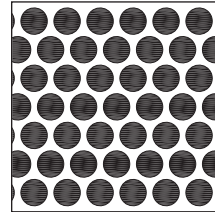

J
250R312S
0.25" Diameter holes
0.312" Staggered centers
58.2% Open area

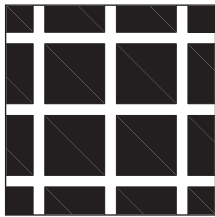

Q
562S672L
0.5625" Square holes
0.672" Straight centers
70% Open area

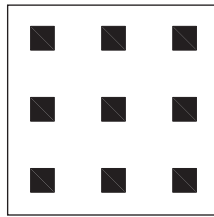

R
250S750L
0.25" Square holes
0.75" Straight centers
11.1% Open area

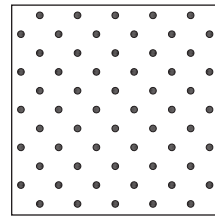

V
62R250D
0.0625" Diameter holes
0.25" Diagonal centers
4.9% Open area

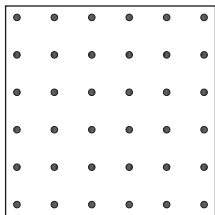

AA
62R354L
0.0625" Diameter holes
0.354" Straight centers
2.5% Open area

See the Rockfon® Perforations Brochure for graphic representations of the perforations listed and the complete offering of Premium Perforations available.

Acoustical Performance



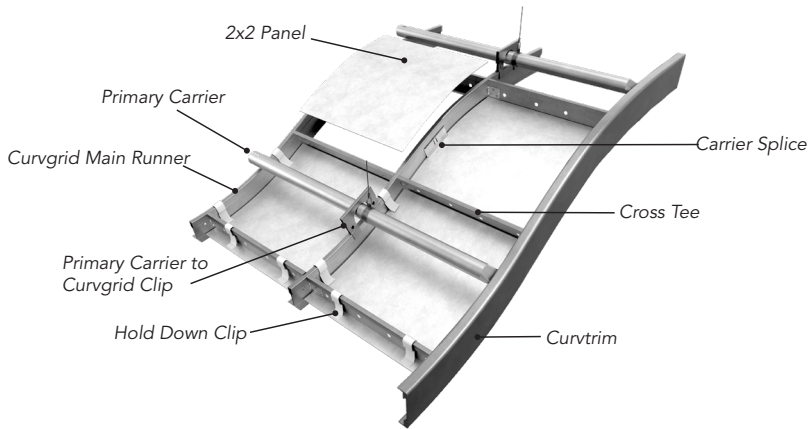

Rockfon Curvgrid System	NRC
NRC - Perforated with Acoutex Backer	0.70
NRC - Perforated with 1-1/2" Acoustical Pad	0.90

Rockfon® Curvgrid™ Two-directional System

Suspension



Suspension Components

Main Runner	Description	Catalog Number	Rockfon Part Number	Length	Height	Recycled Content
	Curved Main Runner Concave*	385.00.xxx	252583	As required per design	1-1/2"	30%
	Curved Main Runner Convex*	385.00.xxx	252583	As required per design	1-1/2"	30%
	Curvgrid Main Runner Straight Sections	385.00.xxx	252583	As required per design	1-1/2"	30%
	Primary Carrier Black	481.024.008	249651	As required per design	1-1/2"	30%
	Perimeter Cross Tee 2'	393.01.002.xxx	per order	As required per design	1-1/2"	30%
	Field Cross Tee 2'	383.00.002.xxx	per order			



*Minimum convex and concave suspension radius is 36".

Curvgrid suspension is made to order per the ceiling design. For pricing and ordering information, please contact Estimating at 1-800-323-7164 or estimating@rockfon.com

Rockfon® Curvgrid™ Two-directional System

Perimeter Trim

Curvtrim Extruded Aluminum Trim - Straight and Curved

Curvtrim Extruded Aluminum Trim	Description	Catalog Number	Rockfon Part Number	Length	Height	Recycled Content
	Curvtrim Straight	290.225.xxx	252584	As required per design	3/4" x 2-1/8" x 3/4"	85%
	Curvtrim Concave Curve*	291.225.xxx	252584	As required per design	3/4" x 2-1/8" x 3/4"	85%
	Curvgrid Convex Curve*	291.225.xxx	252584	As required per design	3/4" x 2-1/8" x 3/4"	85%

*Minimum convex and concave perimeter trim radius is 36".

Curvtrim Perimeter Trim is made to order per the ceiling design. For pricing and ordering information, please contact Estimating at 1-800-323-7164 or estimating@rockfon.com

Rockfon® Curvgrid™ Two-directional System

Accessory Items

Product	Description	Catalog Number	Rockfon Material Number	Packaging
	Primary Carrier Splice	444.00	249367	Per order
	Primary Carrier Hanger Clip	441.00	250328	Per order
	Clear Hold Down Clip	8886.00	250382	100 pcs per carton
	Panel Clip	445.00	250329	Per order
	Primary Carrier to Curvgrid Clip	442.00	249365	Per order
	Primary Carrier to Curvtrim Clip	443.00	249366	Per order
	Curvgrid Main Tee Splice	436.00	250327	Per order
	Hold Down Insert	437.00	249364	Per order
	Outside Corner Clip	429.00	249360	Per order
	Curvtrim Splice Plate	434.00	249363	Per order
	Grid Attachment Clip	433.00	249362	Per order

Rockfon® Curvgrid™ Two-directional System

Acoustical Insulation



Acoustical Pads - Black Vinyl Wrapped

Description	Size	Color	Catalog Number	Rockfon Reference Number
Polywrapped Acoustical Pad 1" x 1"	2' x 2'	Black	58.01.059.008	250505
Polywrapped Acoustical Pad 1" x 1"	2' x 4'	Black	58.01.061.008	250507
Polywrapped Acoustical Pad 1-1/2" x 1"	2' x 2'	Black	58.01.064.008	250509
Polywrapped Acoustical Pad 1-1/2"x 1"	2' x 4'	Black	58.01.063.008	250508

Acoustical Performance

Rockfon Curvgrid System	NRC
NRC - Perforated with Acoutex Backer	0.70
NRC - Perforated with 1-1/2" Acoustical Pad	0.90



Rockfon® Curvgrid™ Two-directional System Properties

Material

.032 Aluminum and Galvanized Steel



Fire Performance

Surface burning characteristics:
UL723 (ASTM E84) Flame Spread Index: 0
Smoke Developed Index (UL Labeled): 0



Environment

Recycled content:
85% Aluminum
30% Steel
100% locally recyclable



Warranty

1-Year Limited Product Warranty
See rockfon.com



Hygiene

Metal provides no sustenance
to microorganisms



Cleaning

Damp cloth

031122

Rockfon

4849 S. Austin Ave.
Chicago, IL 60638 USA